

Triple Power Lithium-ion Battery User Manual

45Ah/63Ah



EN

Solax Power Network Technology(Zhe jiang) Co., Ltd. (Solax Power Co., Ltd)

No.288 Shizhu Road, Tonglu Economic Development Zone,
Tonglu City, Zhejiang province, China.

Tel: +86 0571-56260011

E-mail: info@solaxpower.com

614.00331.01

Copyright Declaration

The copyright of this manual belongs to Solax Power Network Technology(Zhe jiang) Co., Ltd. (SolaX Power Co.,Ltd.). Any corporation or individual should not plagiarize, partially or fully copy (including software,etc.), and no reproduction or distribution of it in any form or by any means. All rights reserved. SolaX Power Network Technology (Zhe jiang) Co.,Ltd. (SolaX Power Co.,Ltd.) reserves the right of final interpretation.

www.solaxpower.com

Contents

1	NOTE ON THIS MANUAL.....	1
1.1	SCOPE OF VALIDITY.....	1
1.2	TARGET GROUP.....	1
1.3	SYMBOLS USED.....	1
2	SAFETY.....	2
2.1	SAFETY INSTRUCTIONS.....	2
2.1.1	GENERAL SAFETY PRECAUTIONS.....	2
2.1.2	EXPLANATION OF SYMBOLS.....	3
2.2	RESPONSE TO EMERGENCY SITUATIONS.....	5
2.2.1	LEAKING BATTERIES.....	5
2.2.2	FIRE.....	5
2.2.3	WET BATTERIES AND DAMAGED BATTERIES.....	5
2.3	QUALIFIED INSTALLER.....	6
3	PRODUCT INTRODUCTION.....	7
3.1	PRODUCT OVERVIEW.....	7
3.1.1	DIMENSION AND WEIGHT.....	7
3.1.2	APPEARANCE.....	8
3.2	BASIC FEATURES.....	10
3.2.1	FEATURES.....	10
3.2.2	CERTIFICATIONS.....	10
3.3	SPECIFICATIONS.....	11
3.3.1	T-BAT SYS-HV CONFIGURATION LIST.....	11
3.3.2	PERFORMANCE.....	11
4	INSTALLATION.....	12
4.1	INSTALLATION PREREQUISITES.....	12
4.2	SAFETY GEAR.....	12
4.3	TOOLS.....	13
4.4	INSTALLATION.....	13
4.4.1	CHECK FOR TRANSPORT DAMAGE.....	13
4.4.2	UNPACKING.....	13
4.4.3	PACKING LIST.....	14
4.4.4	INSTALL BMS TO BATTERY MODULE.....	16
4.4.5	MOUNTING STEPS.....	17

4.5	CABLE CONNECTION.....	19
4.5.1	CONNECTING POWER CABLES.....	19
4.5.2	CONNECTING RS485 COMMUNICATION CABLE.....	23
4.5.3	CONNECTING CAN COMMUNICATION CABLE.....	24
4.5.4	CONNECTING GROUND WIRE.....	25
4.5.5	CONNECTING CHARGING CABLE.....	25
4.6	OVERVIEW OF INSTALLATION.....	26
5	COMMISSIONING.....	27
5.1	CONFIGURING BATTERY SYSTEM.....	27
5.2	COMMISSIONING.....	29
5.3	STATUS INDICATORS.....	30
5.3.1	BMS (MC0500).....	30
5.3.2	BATTERY MODULE (HV10045/HV10063).....	31
5.3	SHUTTING DOWN T-BAT SYSTEM.....	31
6	TROUBLESHOOTING.....	32
6.1	TROUBLE SHOOTING.....	32
7	DECOMMISSIONING.....	34
7.1	DISMANTLING THE BATTERY.....	34
7.2	PACKAGING.....	34

1 Note on this Manual

1.1 Scope of Validity

This manual is an integral part of T-BAT Series. It describes the assembly, installation, commissioning, maintenance and failure of the product. Please read it carefully before operating.

T-BAT BMS

MC0500 (Master Box)

T-BAT Module-HV

HV10045 (T45)

HV10063(T63)

Note: There are 8 models for T-BAT system, which includes BMS and battery module(s). Please refer to section 3.3.1 **T-BAT SYS-HV Configuration List** on page 11 for detailed models.

1.2 Target Group

This manual is for qualified electricians. The tasks described in this manual may only be performed by qualified electricians.

1.3 Symbols Used

The following types of safety instructions and general information appear in this document described as below:



Danger!

"Danger" indicates a hazardous situation which, if not avoided, will result in death or serious injury.



Warning!

"Warning" indicates a hazardous situation which, if not avoided, could result in death or serious injury.



Caution!

"Caution" indicates a hazardous situation which, if not avoided, could result in minor or moderate injury.



Note!

"Note" provides tips that are valuable for the optimal operation of your product.

2 Safety

2.1 Safety Instructions

For safety reasons, installers are responsible for familiarizing themselves with the contents of this manual and all warnings before performing installation.

2.1.1 General Safety Precautions

Warning!

Please don't crush or impact the battery, and always dispose it according to the safety regulation.

Observe the following precautions:

- Risks of explosion
 - Do not subject the battery module to strong impacts.
 - Do not crush or puncture the battery module.
 - Do not dispose of the battery module in a fire.
- Risks of fire
 - Do not expose the battery module to temperatures in excess of 60°C.
 - Do not place the battery module near a heat source, such as a fireplace.
 - Do not expose the battery module to direct sunlight.
 - Do not allow the battery connectors to touch conductive objects such as wires.
- Risks of electric shock
 - Do not disassemble the battery module.
 - Do not touch the battery module with wet hands.
 - Do not expose the battery module to moisture or liquids.
 - Keep the battery module away from children and animals.
- Risks of damage to the battery module
 - Do not allow the battery module to get in contact with liquids.
 - Do not subject the battery module to high pressures.
 - Do not place any objects on top of the battery module.

T-BAT SYS-HV can be used only in the household energy field. It is not allowed to be used in other industries, such as the medical equipment and automotive application.





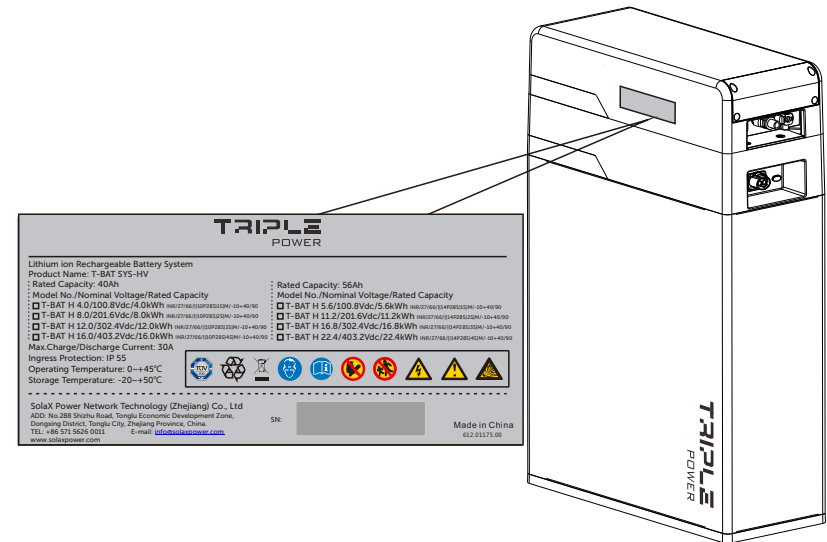





2.1.2 Explanation of Symbols

This section gives an explanation of all the symbols shown on the T-BAT system and on the warning label.



Caution!

If the battery is not installed within one month after receiving the battery, the battery must be charged for maintenance.

Symbol	Explanation
	TUV mark for IEC62619
	The battery system should be disposed of at a proper facility for environmentally safe recycling.
	The battery system should not be disposed together with the household waste. Disposal information can be found in the enclosed documentation.
	Wear protective glasses
	Observe enclosed documentation.
	Keep the battery system away from open flames or ignition sources.
	Keep the battery system away from children.
	Danger of high voltages. Danger to life due to high voltages in the battery system!
	Danger. Risk of electric shock!
	The battery module may explode.

2.2 Response to Emergency Situations

2.2.1 Leaking Batteries

If the battery leaks electrolyte which is corrosive, avoid contact with the leaking liquid or gas. Direct contact may lead to skin irritation or chemical burns. If one is exposed to the leaked substance, do these actions:

Accidental inhalation of harmful substances: Evacuate people from the contaminated area, and seek medical attention immediately.

Eye contact: Rinse eyes with flowing water for 15 minutes, and seek medical attention immediately.

Dermal contact: Wash the affected area thoroughly with soap and water, and seek medical attention immediately.

Ingestion: Induce vomiting, and seek medical attention immediately.

2.2.2 Fire

In case of a fire, make sure an ABC or carbon dioxide extinguisher is nearby.



Warning!

The battery module may catch fire when heated above 150°C.

If a fire breaks out where the battery module is installed, do these actions:

1. Extinguish the fire before the battery module catches fire;
2. If the battery module has caught fire, do not try to extinguish the fire. Evacuate people immediately.

Warning!

If the battery module catches fire, it will produce noxious and poisonous gases. Do not approach.

2.2.3 Wet Batteries and Damaged Batteries

If the battery module is wet or submerged in water, do not try to access it. If the battery module seems to be damaged, they are not fit for use and may pose a danger to people or property.

Please pack the battery in its original container, and then return it to SolaX or your distributor.

Caution!

Damaged batteries may leak electrolyte or produce flammable gas. If you suspect such damage, immediately contact SolaX for advice and information.

2.3 Qualified Installer

Warning!

All operations of T-BAT SYS-HV relating to electrical connection and installation must be carried out by qualified personnel.

A skilled worker is defined as a trained and qualified electrician or installer who has all of the following skills and experience:

- Knowledge of the functional principles and operation of on-grid systems
- Knowledge of the dangers and risks associated with installing and using electrical devices and acceptable mitigation methods
- Knowledge of the installation of electrical devices
- Knowledge of and adherence to this manual and all safety precautions and best practices

3 Product Introduction

3.1 Product Overview

For safety reasons, installers are responsible for familiarizing themselves with the contents of this manual and all warnings before performing installation.

3.1.1 Demension and Weight

A battery management system (BMS) is any electronic system that manages a rechargeable battery.

Battery module is a type of electrical battery which can be charged, discharged into a load.

A battery system includes BMS and battery module(s).

	MC0500	HV10045	HV10063
Length	461mm	464mm	464mm
Width	189mm	193mm	193mm
Height	105mm	588mm	588mm
Weight	5.7kg	56.6kg	67.5kg

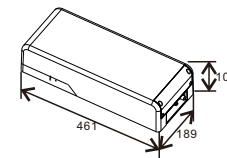

BMS
(MC0500)

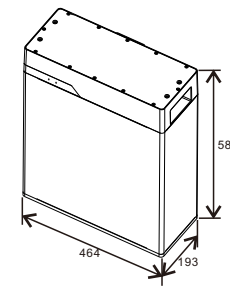

Battery Module
(HV10045/HV10063)

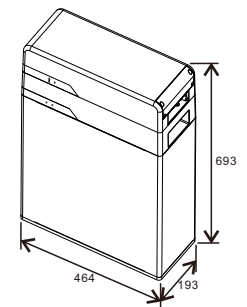

T-BAT SYS-HV
(BMS+battery module(s))

3.1.2 Appearance

- Section view of MC0500

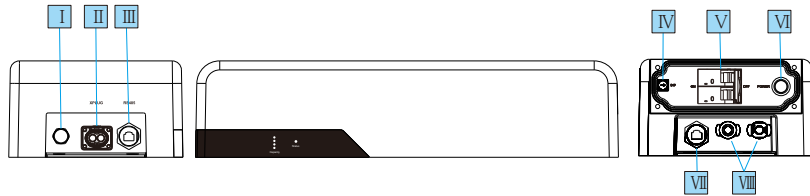

Object	Mark	Description
I	/	Air Valve
II	XPLUG	Power Connector
III	RS485	RS485 Connector
IV	DIP	DIP Switch
V	ON/OFF	Circuit Breaker
VI	POWER	Power Button
VII	CAN	CAN Connector
VIII	BAT+/BAT-	Charge/Discharge Connectors

- Section view of HV10045/HV10063

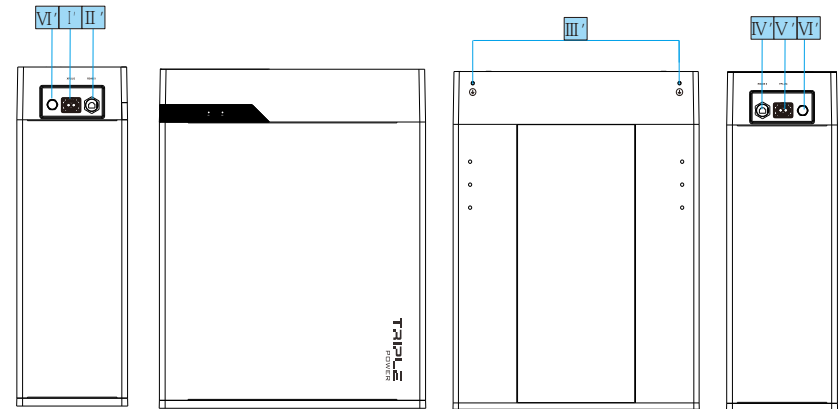

Object	Mark	Description
I'	XPLUG	Power Connector to BMS, or YPLUG of upper battery module
II'	RS485 I	RS485 Connector to BMS, or RS485 II of upper battery module
III'	GND	GND
IV'	RS485 II	RS485 Connector to RS485 I of next battery module
V'	YPLUG	Power Connector to XPLUG of next battery module
VI'	/	Air valve

3.2 Basic Features

3.2.1 Features

The T-BAT SYS-HV is one of the advanced energy storage systems on the market today, incorporating state-of-the-art technology, high reliability, and convenient control features shown as below:

- 90% DOD
- 99% Faradic charge efficiency
- 95% Battery roundtrip efficiency
- Cycle life > 6000 times
- Secondary Protection by hardware
- IP55 protection level
- Safety & Reliability
- Small occupied area
- Floor or wall mounting

3.2.2 Certifications

T-BAT system safety	CE, FCC, RCM, TUV (IEC 62619), UL 1973
Battery cell safety	UL 1642
UN number	UN 3480
Hazardous materials classification	Class 9
UN transportation testing requirements	UN 38.3
International protection marking	IP 55

3.3 Specifications

3.3.1 T-BAT SYS-HV Configuration List

No.	Model	BMS	Battery Module	Energy(kWh)	Voltage (V)
1	T-BAT H4.5	MC0500x1	HV10045X1	4.5	85-118
2	T-BAT H9.0	MC0500x1	HV10045X2	9	170-236
3	T-BAT H13.5	MC0500x1	HV10045X3	13.5	255-354
4	T-BAT H18.0	MC0500x1	HV10045X4	18	340-472
5	T-BAT H6.3	MC0500x1	HV10063X1	6.3	85-118
6	T-BAT H12.6	MC0500x1	HV10063X2	12.6	170-236
7	T-BAT H18.9	MC0500x1	HV10063X3	18.9	255-354
8	T-BAT H25.2	MC0500x1	HV10063X4	25.2	340-472

3.3.2 Performance

	MC0500	HV10045	HV10063
Nominal Voltage(Vdc)	/	100.8	100.8
Operating Voltage(Vdc):	70-500	85-118	85-118
Nominal Capacity(Ah):	/	45	63
Max. charge/discharge Current(A) :	30	30	30
Recommend Charge/Discharge Current (A):	25	25	25
Standard Power(kW)	/	2.5	2.5
Maximum Power(kW)	/	3	3
Faradic Charge Efficiency(25°C/77°F)	99%		
Battery Roundtrip Efficiency(C/3,25°C/77°F)	95%		
Expected Lifetime(25°C/77°F)	5 years		
Cycle life(100% DOD,25°C/77°F)	6000 cycles		
Available Operating Temperature	0-40°C		
Optimal Operating Temperature	15°C-30°C		
Storage Temperature	-20°C-60°C		
Ingress Protection	IP55		

4 Installation

4.1 Installation Prerequisites

When assembling the system, avoid touching the battery terminal with any metal objects or human body. T-BAT SYS-HV provides a safe source of electric energy when operated as designed. Potentially hazardous circumstances such as excessive heat or electrolyte leakage may occur under improper operating conditions, damage, misuse and abuse. The previous safety precautions and the warning messages described in this section must be observed. If any of the previous precautions are not fully understood, or if you have any questions, contact customer service for guidance. The Safety Section may not include all regulations for your region.

Make sure that the installation location meets the following conditions:

- The building is designed to withstand earthquakes
- The location is far away from the sea, to avoid salt water and humidity
- The floor is flat and level
- There are no flammable or explosive materials nearby
- The ambience is shady and cool, keep away from heat and avoid direct sunlight.
- The temperature and humidity stays at a constant level.
- There is minimal dust and dirt in the area.
- There is no corrosive gases present, including ammonia and acid vapor.

Note!

If the ambient temperature is outside the operating range, the battery module stops operating to protect itself. The optimal temperature range for the battery module to operate is 15°C to 30°C. Frequent exposure to harsh temperatures may deteriorate the performance and lifetime of the battery module.

4.2 Safety Gear

Installation and maintenance personnel must operate according to applicable federal, state and local regulations as well as the industry standards regarding the product installation personnel shall wear safety gears, etc. in order to avoid short circuit and personal injury.



Insulated gloves



Safety goggles



Safety shoes

4.3 Tools

These tools are required to install the T-BAT system.



Torque screw driver



Phillips-screw driver

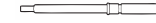

Hexagon wrench



Phillips-head screw driver



Flat-head screw driver



Torque wrench

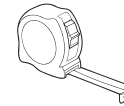

Tape measure



Drill



Pencil or Marker

4.4 Installation

4.4.1 Check for Transport Damage

Make sure the battery is intact during transportation. If there are some visible damages, such as cracks, please contact your dealer immediately.

4.4.2 Unpacking

Unpacking the battery package by cutting the packing tape and make sure the battery modules and the relevant items are complete. See package items on section 4.4.3, please check the packing list carefully, if there's any item missing, please contact SolaX or your distributor directly.

Caution!

According to regional regulations, several people may be required for moving equipment.

Warning!

Please strictly follow the installation steps. SolaX will not answer for any hurting or loss arising by incorrectly assembling and operation.

4.4.3 Packing List

BMS (Master Box):

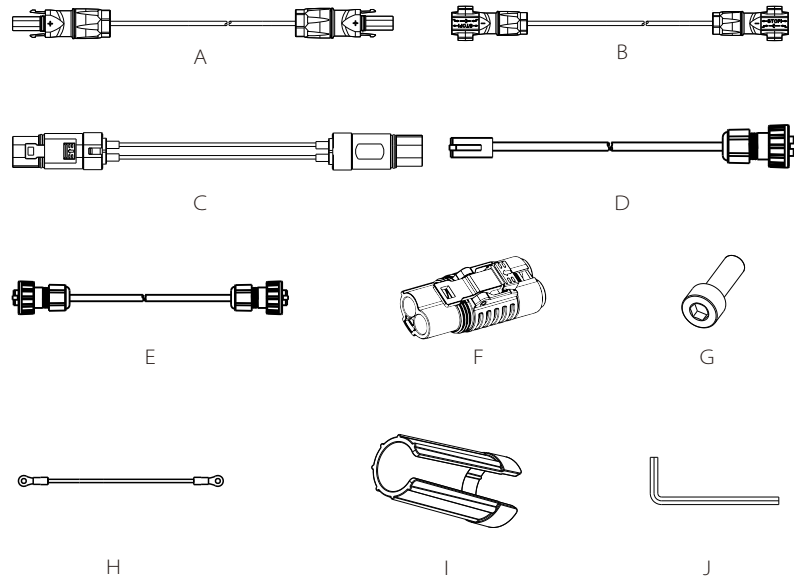

The table below lists the number of each component.

Object	Description	Quantity
A	Charging cable (+)	1
B	Charging cable (-)	1
C	Power cable between BMS and battery module (120mm)	1
D	CAN communication cable (2m)	1
E	RS485 communication cable (120mm)	1
F	Short-circuit plug	1
G	M5 screw	4
H	Ground wire	1
I	Rotation wrench	1
J	L-type wrench	1

Battery Module (T45/T63):

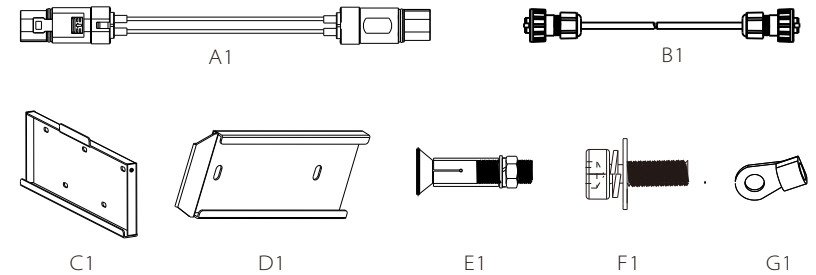

Object	Description	Quantity
A1	Power cable between battery modules (400mm)	1
B1	RS485 communication cable (400mm)	1
C1	Wall mounting backboard	1
D1	Floor mounting backboard	1
E1	Expansion screw sleeve	5
F1	M6 screw	1
G1	Ring terminal (for grounding)	2

4.4.4 Install BMS to Battery Module

Assemble the BMS to the battery module, and fix it with M5 screws (G) on the point where marked as below by using L-type wrench (J). Please pay attention to put the same side of BMS and battery modules, which means to put the front side that has status panel at the same side.

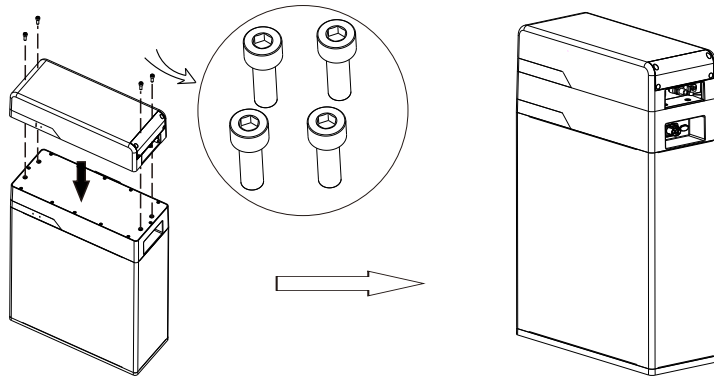

Caution!

Make sure that the system is always exposed to the ambient air. The system is cooled by natural convection. If the system is entirely or partially covered or shielded, it may cause the system to stop operating. Please estimate the length of grounding cable first, because the ground port is designed at the back side of BMS and battery module. Please refer to section **4.5.4 Connecting Ground Wire** for more information.

Caution!

There are two mounting modes for choice: floor mounting mode and wall mounting mode. Customers can choose either mode according to the needs. However, only one option is available, once you choose one of the mode and start to install, you have to find the appropriate expansion screw sleeves if you want to change the mounting mode. Floor mounting or wall mounting is a mandatory requirement for installation. Wrong cable connection might occur if the battery modules don't put in a row with the front panel in the same side. Finish the floor mounting or wall mounting before connecting cables.

4.4.5 Mounting Steps

Note!

The space between battery modules shall be more than 250mm.

Floor mounting:

Step 1: fix the wall bracket on the wall

- The distance between the bottom of battery module and the lower hole of wall bracket is 375mm, measure it and mark the position of the two holes
- Drill holes with driller, make sure the holes are deep enough (at least 50mm) for install and tight the expansion screw sleeves
- Install the expansion screw sleeves (E1) in the wall, and screw the wall bracket (D1) by using the wrench.

Step 2: Remove the lower hanging board which has been installed already.

Step 3: Match the battery module with wall bracket (D1)

- Transport the battery module to the wall bracket
- Hang the battery module over the wall bracket, move the battery module close to it, and match it on the wall bracket

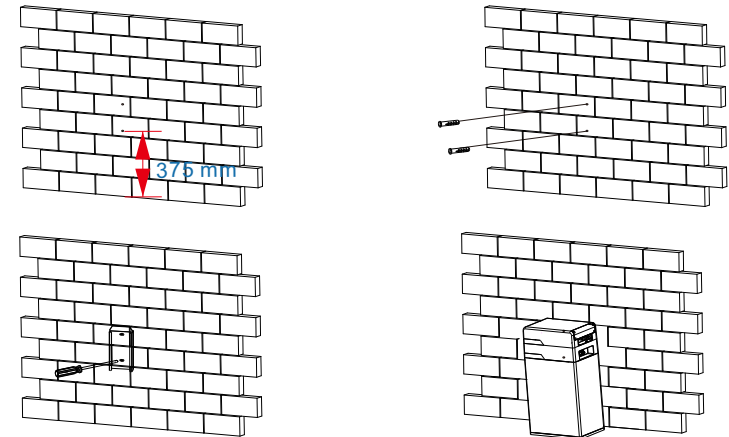

The following figure is the back view of floor mounting.

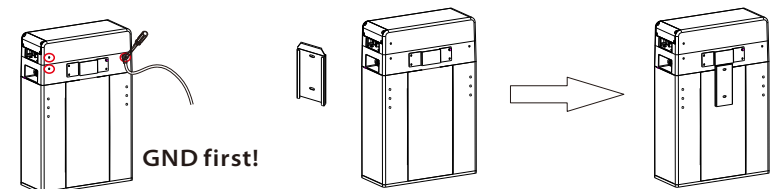

Wall mounting:

Make sure the wall is strong enough to withstand the weight of battery modules.

Step 1: fix the wall bracket (C1) on the wall

- Use the wall bracket as a template to mark the position of the 5 holes
- Drill holes with driller, make sure the holes are deep enough (at least 50mm) for install and tight the expansion screw sleeves
- Install the expansion screw sleeves (E1) in the wall, and screw the bracket by using the wrench.

Step 2: Remove the upper hanging board which has been installed already.

Step 3: Match the battery module with the wall bracket

- Transport the battery module to the wall bracket
- Hang the battery module over the wall bracket, move the battery module close to it, and match it on the wall bracket

Step3: Lock the joint between hanging board and wall bracket with M6 screw(F1).

Note: Keep the distance from installation point to the floor less than 1m.

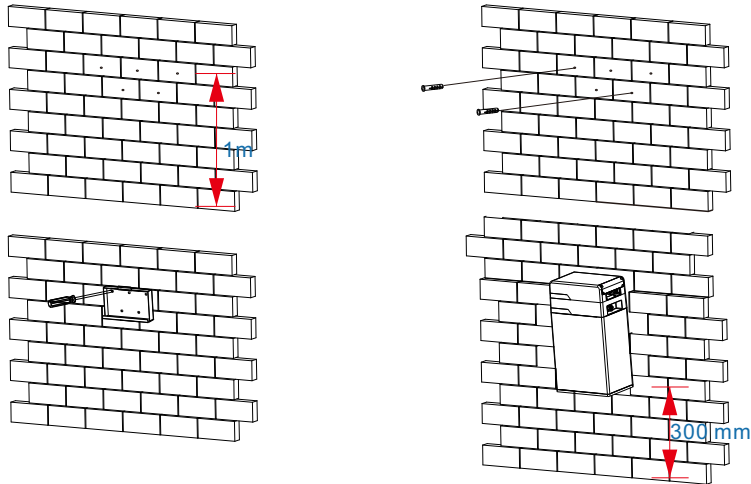

The following figure is the back view of wall mounting.

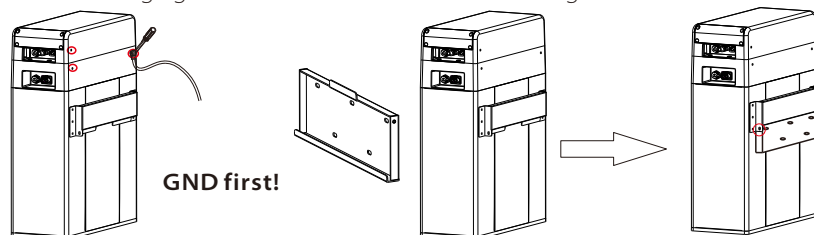
**4.5 Cable Connection****4.5.1 Connecting Power Cables****For one battery module:**

The color at both end of the power cable between BMS and battery module (C) is orange, and this color is connected to XPLUG which is on the left side of the BMS (II) and battery module (I).

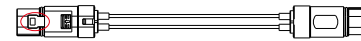

1. Plug either end of the power cable to XPLUG on BMS (II) and battery module (I). When the metal sheet which is marked in red is totally inserted and a click sound is heard, that means the power cable is completely connected.

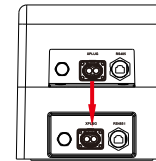

2. Please make sure that both ends of the power cable are connected to the correct connector, which are on the left side of BMS and battery module that shown in the figure.

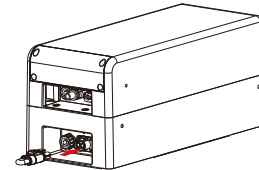

3. After the battery module were correctly connected, plug the short-circuit plug (F) at the right side of battery module (V) to make a complete circuit.

Overview of Step 2 and Step3:

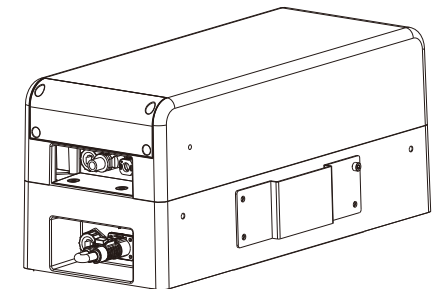
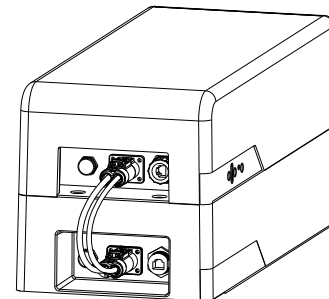

Notes for Unplugging Power Cables

⚠ Caution!

Forbid to plug/unplug power cables when the T-BAT system is not turned off, otherwise there will be an arc discharge that hurt human body!

1. Shut down the T-BAT system (Please refer to **Section 5.4 Shutting Down T-BAT System** of User Manual on page 30);
2. Remove the lock cover
 - a. Pull at back end of the lock cover with finger or an instrument;
 - b. Remove the lock cover and keep it for next time.

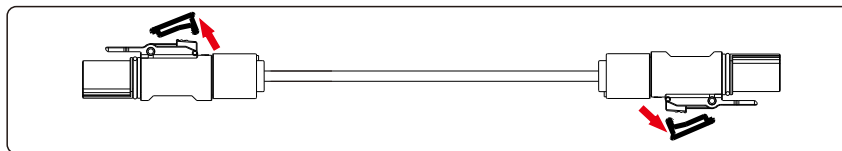
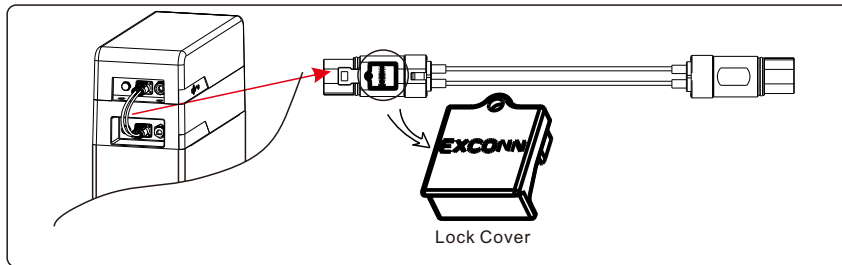

3. Push the plastic button on each end of the power cable in the direction of the arrow;
4. Unplug the power cable.

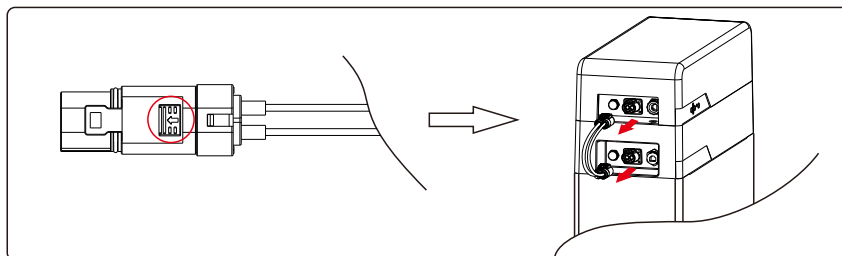

For 2~4 battery modules:

The power cable between battery modules (A1) is different from the one that between BMS and battery module (C). The other end of the power cable is black, and this color is connected to YPLUG (V'), which is on the right side of the battery module.

1. Connect YPLUG (V') on the right side of battery module to XPLUG (I') on the left side of the second battery module. The rest battery modules are connected in the same way. The following figure shows that four battery modules are connected.

⚠ Note!

Make sure that GND has been finished before the cable connection!

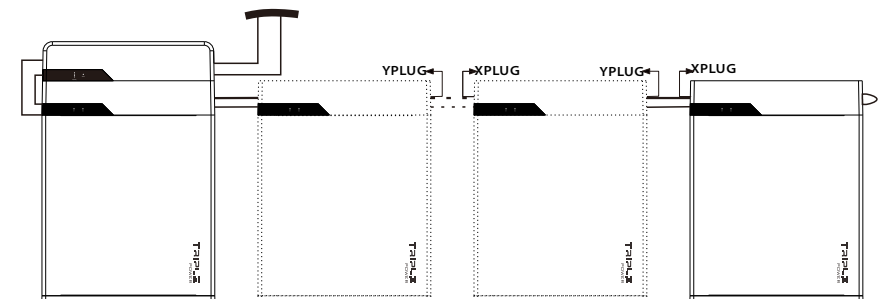
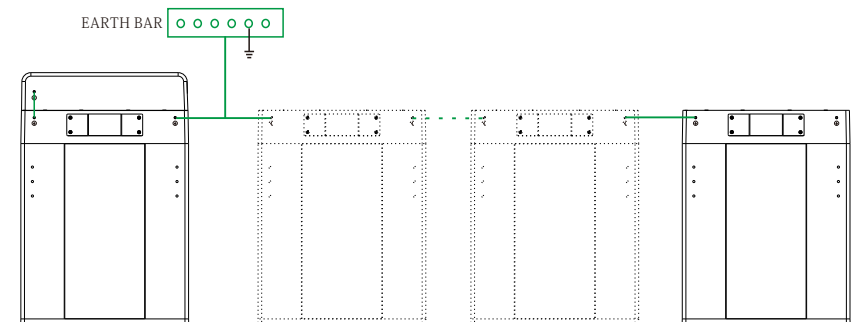

2. After all the battery modules were correctly connected, plug the short-circuit plug (F) at YPLUG (V') of last battery module to make a complete circuit.

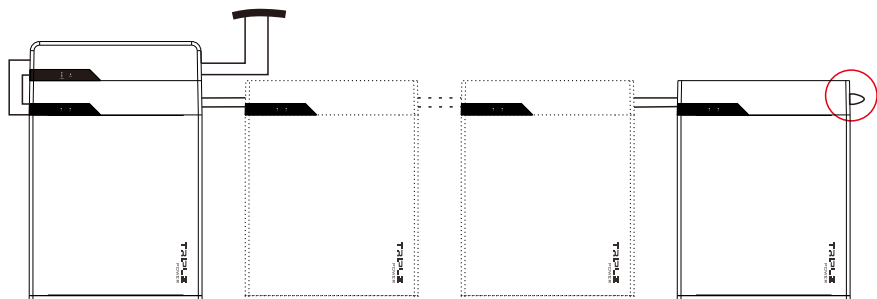

⚠ Danger!

Touch the two sheetmetals of the power connector will get an electric shock, DO NOT touch them! Also DO NOT connect XPLG to YPLG on the same battery module!



4.5.2 Connecting RS485 Communication Cable

For one battery module:

1. There's a protect cover for the RS485 connector, unscrew the cover and plug one end of the RS485 communication cable to the RS485 connector. Tighten the plastic screw nut which is set on the cable with rotation wrench.
2. Connect the RS485 communication cable (E) from BMS on the left side (III) to the RS485 I communication port (II') that is on the left side of the battery module. The communication ports are marked at the following figure.

For 2~4 battery modules:

1. There's a protect cover for the RS485 connector, unscrew the cover and plug one end of the RS485 communication cable to the RS485 connector. Tighten the plastic screw nut which is set on the cable with rotation wrench.
2. Connect the RS485 communication cable (E) from BMS on the left side (III) to the RS485 I communication port (II') that is on the left side of the battery module. The communication ports are marked at the following figure.
3. Connect RS485 II (IV') of upper battery module on the right side to RS485 I (II') of the follow-up battery module.

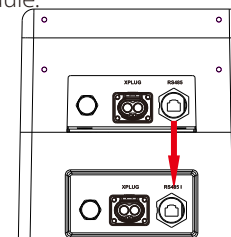

The wire order of the communication cable is as follows:

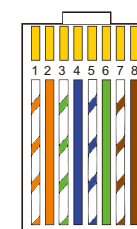
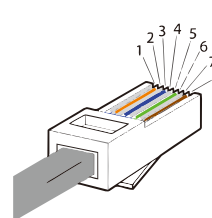

- 1) White with an orange stripe
- 2) Orange
- 3) White with a green stripe
- 4) Blue
- 5) White with a blue stripe
- 6) Green
- 7) White with a brown stripe
- 8) Brown

Sequence	1	2	3	4	5	6	7	8
RS485I	VCC_485	GND_485	B2	N-	P+	A2	VCC_485_2	GND_485
RS485II	VCC_485	GND_485	B2	N-	P+	A2	VCC_485_2	GND_485

4.5.3 Connecting CAN Communication Cable

It is required for the BMS to communicate with the inverter for proper operation.

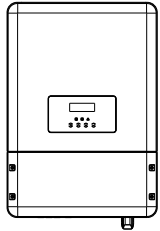

1. Turn off the Inverter AC switch, insert one end of the CAN communication cable (D) to the CAN port on the Inverter. Assemble the cable gland and screw the cable nut.

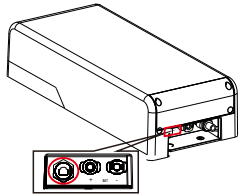

2. Connect the CAN communication cable to the CAN connector (VII) which is marked in red.

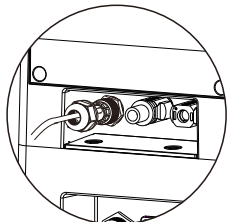

3. There's a protect cover for the CAN connector, unscrew the cover and plug the other end of the CAN communication cable to the CAN connector. Tighten the cover which is set on the cable.

The wire order of the communication cable is the same as RS485 communication cable

Sequence	1	2	3	4	5	6	7	8
CAN	/	/	/	CAN_H	CAN_L	/	A1	B1

4.5.4 Connecting Ground Wire

Unscrew the ground terminal with hexagon wrench on BMS and battery module at either side of the ground port as marked at the following figure. Connect the ground wire from BMS to battery module.

10AWG ground wire is required for grounding.

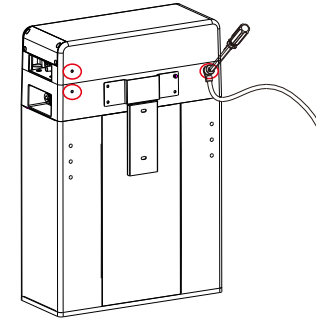

Caution!

GND is mandatory!

4.5.5 Connecting Charging Cables

This step is going to connect charging cables between Inverter and T-BAT system.

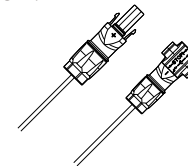

1. Connect the charging cables between Inverter and BMS. Please pay attention to connect the charging cables (+,-) to the correct port on both Inverter and BMS.

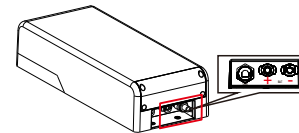

2. Connect the negative cable (-) (B) to the port on the right and the positive cable (+) (A) to the one on the left shown as in the figure.

Note!

1. When connecting the cable to Inverter, fit the two connectors together until the connection audibly locks into place.
2. Check to make sure the connection is securely locked.
3. Don't shake both ends of the cable at the joint once the connection is locked.

4.6 Overview of Installation

The following diagram is a complete T-BAT system installation with four battery modules.

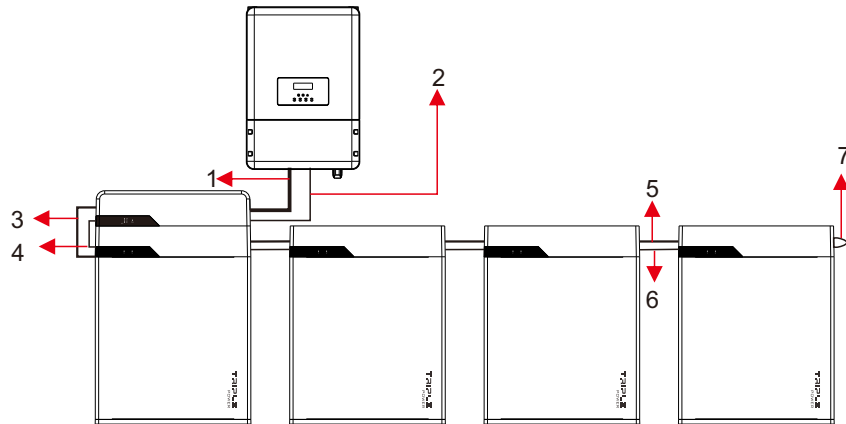

- 1: Charging Cable
- 2: CAN Communication Cable
- 3: Power Cable between BMS and battery module (120mm)
- 4: RS485 Cable between BMS and battery module (120mm)
- 5: Power Cable between battery modules (400mm)
- 6: RS485 Cable between battery modules (400mm)
- 7: Short-circuit plug

Danger!

One T-BAT system is allowed to install at most four battery modules. Connecting more than four battery modules will blow the fuse, and the battery module will be damaged. Please make sure the number of battery modules meets the requirement.

5 Commissioning

5.1 Configuring Battery System

The DIP switch is used to configure the number of battery modules which are communicating to Inverter. The detailed configuration information is shown as follows:

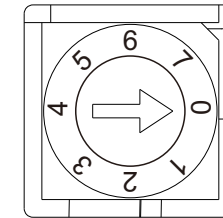

Configuration activated by inverters

- 0- Matching one battery module (default)
- 1- Matching two battery modules
- 2- Matching three battery modules
- 3- Matching four battery modules

Black-start configuration

The black-start function is only used in the off-grid environment and there is no other power supply.

Note: if the battery is started in black-start mode, although there is no BMS communication, the port still has high voltage and there is a risk of electric shock!

After the black-start mode is started, if the BMS communication has still not been built within 3 minutes, the black start fails.

- 4- Matching one battery module
- 5- Matching two battery modules
- 6- Matching three battery modules
- 7- Matching four battery modules

Note!

When powering on the BMS, the system will start self-testing. If the buzzer bips, it means DIP configuration fault or communication failure occurs. If the buzzer bips, please check if the number of battery modules is corresponding to the DIP configuration, and also check if the RS485 communication cables are correctly connected. After these two situations are checked OK, press the POWER button to power on, and press the POWER button again 10s later. In addition: The buzzer will only alarm on the corresponding fault during the power-on self-test. After the self-test is completed, it won't bip again even if the same fault occurs.

5.2 Commissioning

Verify the model number of each battery module to make sure that they are all the same model.

If all the battery modules are installed, follow these steps to put it in operation.

1. Configure the DIP (IV) to corresponding number according to the number of battery module(s) that has(have) been installed;
2. Remove the cover board of BMS;
3. Move the circuit breaker switch (V) to the ON position;
4. Press the POWER button (VI) to turn on the T-BAT system;
5. Reinstall the cover board to BMS;
6. Turn on Inverter AC switch.

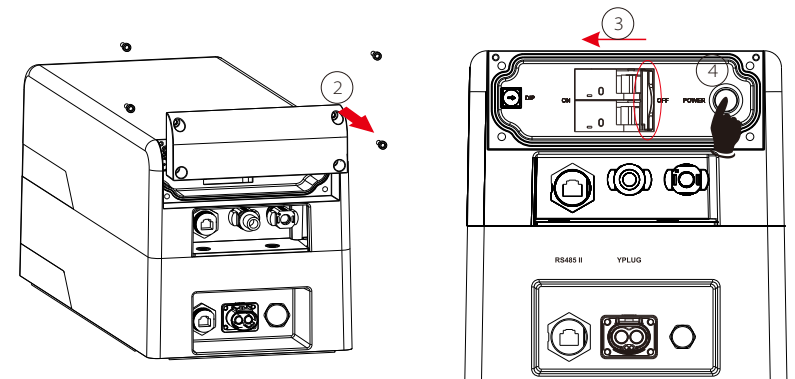
**Note!**

Frequently pressing the POWER button may cause the system error. Please make sure at least 10 seconds is needed when you are going to press the POWER button from the last pressing operation.

5.3 Status Indicators

The LED indicators on the front panel of the BMS and battery modules are showing the operating status.

5.3.1 BMS (Master Box)



The following table shows the status of BMS.

No.	Status of BMS	Mode
1	Green LED flashes once every 5s	Active
2	Yellow LED flashes once every 5s	Warning
3	Red LED flashes once every 5s	Protection
4	Green LED keeps on	Configuring
5	Green LED flashes quickly	Upgrade for BMS

The capacity indicators show the SOC:

- When the battery module is neither charging nor discharging, the indicator lights off.
- When the battery module is charging, part of the blue LED flashes once every 5s, and part of the blue LED keeps on. Take SOC 60% for instance, in charging state:
 1. The last two blue LED indicators keeps on
 2. The last third blue LED indicator flashes once every 5s
- When the battery module is discharging, the blue LED indicators flash once every 5s. Take SOC 60% for instance, in discharging state:
 1. The last three blue LED indicators flash once every 5s



Charging

Discharging

5.3.2 Battery Module (T45/T63)



S1 and S2 represent independent status indicators. The status of S1 and S2 have the same meaning for battery module in the following table.

Note: only when both S1 and S2 are flashing once every 5s in Green LED, it means the battery system is active.

No.	Status of battery module	Mode
1	Green LED flashes once every 5s	Active
2	Yellow LED flashes once every 5s	Protection
3	Red LED flashes once every 5s	Fault
4	Green LED flashes quickly	Upgrade for BMS

Note!

After powering off the BMS, the LED lights of S1 and S2 will keep flashing in 20 minutes.

5.4 Shutting Down T-BAT System

To shut down the system, follow the steps described below:

1. Power off the BMS;
2. Turn off the system by moving the circuit breaker switch to the OFF position;
3. Make sure that every indicator on the T-BAT system is off;
4. Turn off Inverter AC switch.

6 Troubleshooting

6.1 Troubleshooting

Check the indicators on the front to determine the state of the T-BAT system. A warning state is triggered when a condition, such as with voltage or temperature, is beyond design limitations. The T-BAT system's BMS periodically reports its operating state to the inverter.

When the T-BAT system falls outside prescribed limits, it enters a warning state.

When a warning is reported, the inverter immediately stops operation.

Use the monitoring software on the inverter to identify what caused the warning.

The possible warning messages are as follows:

Warning Messages	Description	Troubleshooting
BMS_External_Err	The communication between BMS and Inverter is interrupted	Check if the communication cable between BMS and Inverter is correctly and well connected.
BMS_Internal_Err	1. DIP switch at the wrong position; 2. The communication between battery modules is interrupted	1. Move the DIP switch to the correct position; 2. Check if the communication cable between battery modules is correctly and well connected.
BMS_OverVoltage	Battery over voltage	Please contact SolaX after-sales service or your distributor directly.
BMS_LowerVoltage	Battery under voltage	Please contact SolaX after-sales service or your distributor directly.
BMS_ChargeOCP	Battery charge over current protection	Please contact SolaX after-sales service or your distributor directly.
BMS_DischargeOCP	Battery discharge over current protection	Please contact SolaX after-sales service or your distributor directly.

Warning Messages	Description	Troubleshooting
BMS_TemHigh	Battery over temperature	Wait till the temperature of cells go back to the normal state.
BMS_TemLow	Battery under temperature	Wait till the temperature of cells go back to the normal state.
BMS_CellImblance	The capacities of cells are different	Please contact SolaX after-sales service or your distributor directly.
BMS_Hardware_Protect	Battery hardware under protection	Please contact SolaX after-sales service or your distributor directly.
BMS_Insulation_Fault	Battery insulation fault	Please contact SolaX after-sales service or your distributor directly.
BMS_VoltSensor_Fault	Battery voltage sensor fault	Please contact SolaX after-sales service or your distributor directly.
BMS_TempSensor_Fault	Battery temperature sensor fault	Please contact SolaX after-sales service or your distributor directly.
BMS_CurrSensor_Fault	Battery current sensor fault	Please contact SolaX after-sales service or your distributor directly.
BMS_Relay_Fault	Battery relay fault	1. Make sure the power cable is correctly and well connected to the power connector (XPLUG) of the BMS; 2. If the first step still does not work, please contact SolaX after-sales service or your distributor directly.

7 Decommissioning

7.1 Dismantling the Battery

Shutting down T-BAT system

Disconnect the cables between BMS and Inverter

Disconnect the series wiring terminal on the ended battery.

Disconnect the other cables.

7.2 Packing

Please pack the BMS and battery modules with the original packaging.

If it is no longer available, you can also use an equivalent carton that meets the following requirements.

- Suitable for loads more than 30kg
- With handle
- Can be fully closed